

# Purificare

ENHANCED DISINFECTION

## Ultraviolet Disinfection Systems



Models:

**PFC-8IC**

**PFC-12IC**

**PFC-20IC**

### Installation, Operation and Maintenance Manual

CAUTION: Read and Follow all safety rules and  
operating instructions before first use of product.



*Dealer Info:*

----------------------



# Table of Contents

Installation Instructions:	
General Safety Instructions .....	4
Function / Description .....	5
Installation .....	6
Installation Diagram .....	7
Electronic Controls & Startup Procedures .....	8
Sanitation Procedures: .....	10
Maintenance: .....	12
Unit Parts Breakdown: .....	13
Circuit Board Layout: .....	16
Wiring Diagram: .....	17
Troubleshooting: .....	18
Sterile Water Sample Procedures: .....	19
Specifications: .....	20
Notes: .....	21
Warranty: .....	23

# General Safety Instructions

**WARNING** - to guard against injury, basic safety precautions should be observed, including the following:

## 1. READ AND FOLLOW ALL SAFETY INSTRUCTIONS.

**2. DANGER** - To avoid possible electric shock, special care should be taken since water is present near electric shock equipment. Unless a situation is encountered that is explicitly addressed by the provided maintenance and troubleshooting sections, do not attempt repairs yourself, refer to an authorized service facility.

**3.** Carefully examine the disinfection system after installation. It should not be plugged in if there is water on parts not intended to be wet.

**4.** Do not operate the disinfection system if it has a damaged power cord or plug, if it is malfunctioning or if it is dropped or damaged in any manner.

**5.** Always shut off water flow and unplug the disinfection system before performing cleaning or maintenance activities. Never pull on the power cord to remove it from an outlet. Grab the plug and pull to disconnect.

**6.** Do not use this disinfection system for anything other than the intended use (potable water applications.) The use of attachments not approved, recommended or sold by the manufacturer / distributor may cause an unsafe condition.

**7.** Intended for indoor use. Do not install this disinfection system where it will be exposed to the weather. Do not store this disinfection system where it will be exposed to temperatures below freezing unless all the water has been drained from it and the water supply has been disconnected.

**8.** Read and observe all the important notices and warnings on the water disinfection system.

**9.** If an extension cord is necessary, a cord with a proper rating should be used. A cord rated for less Amperes or Watts than the disinfection system is rated for may cause over heating. Care should be taken to arrange the cord so that it will not be tripped over or accidentally pulled from the outlet.

## 1. SAVE THESE INSTRUCTIONS.

**2. WARNING:** The U.V. light given off by this unit can cause serious burns to unprotected eyes and skin. Never look directly at a lit U.V. lamp. When performing any work on the U.V. Disinfection System, always unplug the unit first. Never operate the U.V. system while the lamp is outside of the U.V. chamber.

**3. WARNING:** The U.V. lamp inside of the disinfection system is rated at an effective life of approximately 9,000 hours. To ensure continuous water treatment, replace the U.V. lamp annually with the appropriate Aqua Treatment Services U.V. lamp. Failure to comply may present a fire hazard.

## Function

The function of this ultraviolet disinfection unit is to provide in excess of 99.9% reduction of all water borne pathogenic (disease causing) bacteria.

Model PFC series have a number code designation correspondent to the maximum GPM (gallons per minute) flow rate of the unit. I.E., PFC-8 has a maximum flow capacity of 8 GPM.

**Applications:** PFC Units are designed to destroy micro-organisms in water supplies. The Ultraviolet lamp peak radiation of 254 nanometer wavelength (nm) destroys or inactivates the D.N.A. (deoxyribonucleic acid) which absorbs the Ultraviolet radiation, preventing cellular reproduction. PFC units meet minimum dosages of 30,000 microwatt second per square centimeter.

### MAXIMUM CONCENTRATION LEVELS BEFORE ULTRAVIOLET:

Turbidity.....	5 NTU	Hardness.....	7 gpg
Color.....	None	Iron.....	0.3 ppm
Manganese.....	0.05 ppm	pH.....	6.5 - 9.5ppm

**Note\*:** Pre-filtration equipment may be required if these parameters cannot be maintained. Flow rate must not exceed

## Description

The PFC series has an unique design with an ultraviolet germicidal lamp housed within a single quartz sleeve surrounded by a stainless steel pressure chamber. The chamber is fabricated out of 304 Stainless Steel.

These units come with an ultraviolet lamp designed with four pins at one end.

The quartz sleeve is intended to be placed through the disinfection chamber and will slightly protrude through the threaded nipple. The ultraviolet lamp is placed within this quartz sleeve. The U.V. light shines through this specially designed hard quartz sleeve for maximum disinfection efficiency to meet the requirements for bacteria reduction in potable water.

The inlet is located on the bottom of the chamber and the outlet can be on either side dependent upon installation. A sight Port is provided for safe and easy view of operation. A bracket is secured to the wall and the chamber is held in place by tightening the lock nut to both mounting bracket and chamber.

# Installation

## GENERAL CONSIDERATIONS FOR ALL DISINFECTION UNITS:

1. When installing the equipment, it is necessary that the unit be isolated from vibration, heavy equipment, and poorly connected piping.
2. Incoming water temperature to the unit should not exceed 35° minimum to 110° maximum degrees Fahrenheit.
3. The operating pressure should not exceed 100 psi.
4. Before putting the unit into final operation follow sanitation procedures as outlined in this manual for proper disinfection. Sanitizing all discharge piping and fittings with household bleach from disinfection unit to point of use removes existing contaminants and gives the unit a “clean start.” Be sure to rinse with U.V. treated water.
5. A proper flow control, included with the unit, must be used to insure only the designated flow through the unit.
6. It is recommended to use U.V. resistant materials when initially installing the unit. The U.V. light can cause PVC or other plastic materials to degrade. Becoming brittle, this can compromise the pipe structural or fitting integrity.

## GENERAL PRECAUTIONS TO BE FOLLOWED AT ALL TIMES:

1. Always disconnect elecPFC power to any U.V. unit before servicing.
2. Under no circumstances should personnel look at a U.V. lamp in operation (EXCEPT through an external sight Port lens located on the outside of the unit).
3. U.V. disinfection units must always be properly grounded. The PFC series are always placed after the pressure tank and any other type of treatment devices (i.e. softeners, filters).

These units are normally installed in a vertical position in an enclosed area with good ventilation. Allow clearance of at least the unit's length at one end for quartz sleeve and lamp replacement. Two (2) anchor bolt holes are provided for proper wall support. Use anchors with screws for sufficient support (not included). A lock nut secures the mounting bracket to the U.V. chamber.

If your piping system is subject to impulse pressure resulting in a “water hammer” condition, a surge tank or other means must be provided to remove this condition; otherwise, this extreme shock pressure condition may rupture or fracture the quartz sleeve.

Make all plumbing connections to allow for ease of service. Be sure to follow all local plumbing codes and U.V. resPFCtion requirements where specified by local

authorities.

## STEP BY STEP INSTALLATION:

1. Turn off the water before cutting into the water line.
  2. Assess the installation (i.e. type of pipe, size of lines, etc.) and obtain necessary plumbing fittings for installation. Inlets and outlets on PFC units are 3/4” FNPT and 1” MNPT. Use Teflon tape on all threaded connections and avoid over tightening.
- Note:** The flow control is a press in type. Each unit has a 3/4” FNPT and 1” MNPT inlet/outlet machined so the flow control can be easily inserted into the bottom port inlet. Make sure the rubber part of the flow control is facing outward from the bottom inlet. Simply hand press or slightly tap in the flow control until it sits on the inside ledge of the machined bottom inlet.
3. Using the mounting bracket provided, secure unit to wall, or other surface. Make sure to allow enough room to install, replace, and clean the quartz sleeve and lamp. Installing a water shut-off valve before and after the unit is recommended to make servicing easy.
  4. After mounting, install quartz sleeve, O-Ring, and lamp per instructions. Turn on the water slowly, check for leaks, and repair as needed prior to full service operation.

5. After the unit is full of water, plug it into a grounded 110V outlet. Observe operation through the safety sight Port. The lamp will show a bright blue glow. If any problems are noted, consult trouble shooting guide.

# Installation Diagram

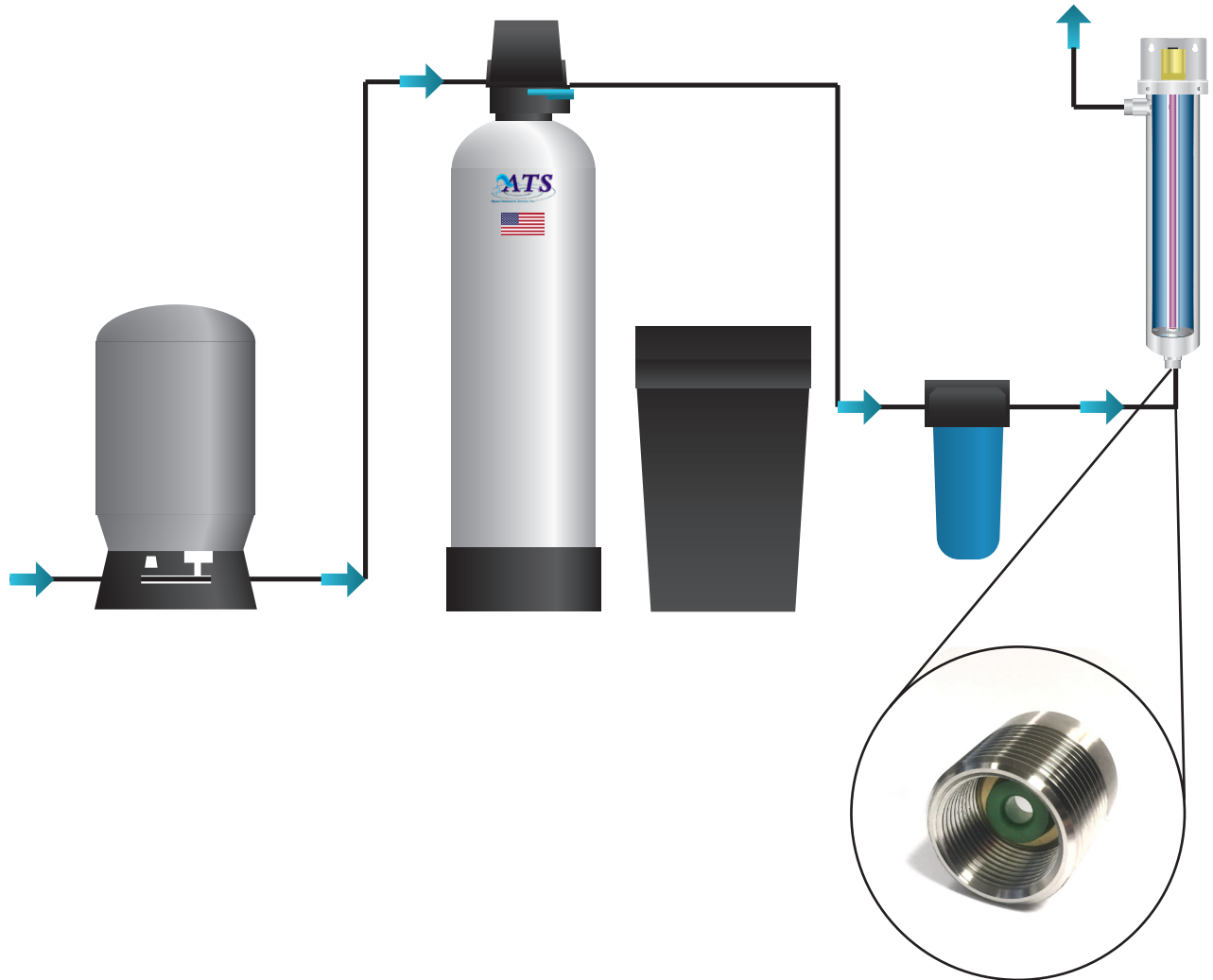



# Electronic Controls & Startup Procedures

## OPERATING INSTRUCTIONS

Your U.V. System is equipped with the ATS-287-2 U.V. Lamp Detector and Timer circuit board which is designed to provide a continuous monitoring system of the UV lamp operational status. This is also equipped with an internal and external fused surge protection system. This solid state electronic circuit board provides the latest in Touchscreen/ U.V. lamp monitoring technology.

## U.V. LAMP / CONTROL BOX START UP PROCEDURE

1. Make sure the U.V. lamp is inserted per instructions into the quartz sleeve and U.V. chamber. Then plug the U.V. lamp into the lamp connector.
2. Plug the electrical control box into a 120V wall plug outlet.
3. Upon start up the U.V. lamp Detector and Timer circuit board will perform a self diagnostic test. When power is applied the circuit board will perform an output check to see if lamp or probe is connected. Once detected, the lamp will light and go into an approximate 2 minute lamp optimization period. **(as shown in Fig 1 - 1D)**
4. Quick Beep
5. The number 364 is displayed representing 364 days remaining
6. Once warmed up, the logo and number of remaining days is displayed.
7. Set the 1 Year Lamp Timer – WITH NEW U.V. LAMP\  
Make sure the control box is plugged into the wall outlet and the U.V. lamp is on. Touch the right green arrow until “Reset lamp” is displayed. Touch the red “reset” button and then touch the green check mark to rest lamp for 1 year. **(as shown in Fig 2 & 2A)**
8. Snooze Alarms
  - Touch  to snooze alarm or touch the  button on display or control box.
9. Alarm screens
  - A. Lamp Out **(as shown in Fig 3 & 3A)**
    - Circuit board has detected lamp out. Unplug unit and check lamp connection, and plug the unit back in.
  - B. Lamp Life Low **(as shown in Fig 4)**
    - Circuit board has detected that there are 30 days

remaining on the lamp life.

**10. Dealer Information** - This screen contains dealer contact information. If you touch the right green arrow you will see a scanable QR code which can be scanned with a smart phone to obtain dealer information. **(as shown in Fig 5 & 5A)**

**11. Software Version** - This screen displays the current software version for the circuit board. **(as shown in Fig 6)**



# Sample Screen Shots

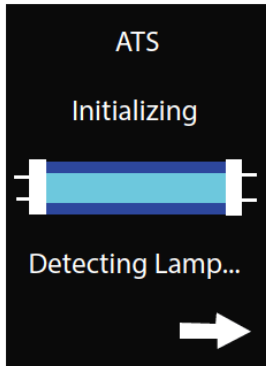

Fig 1

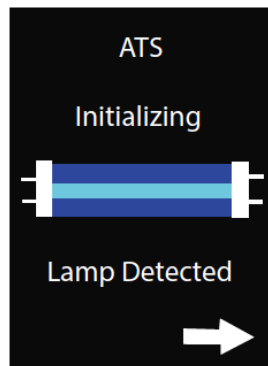

Fig 1A

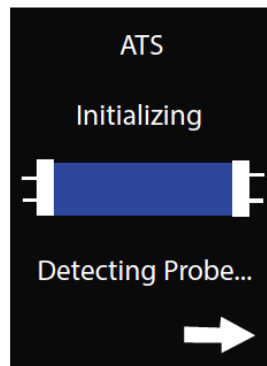

Fig 1B

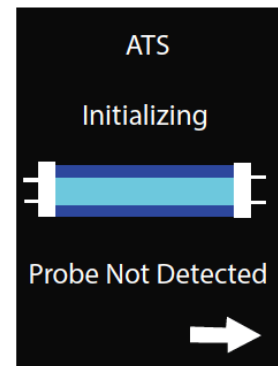

Fig 1C



Fig 1D



Fig 2

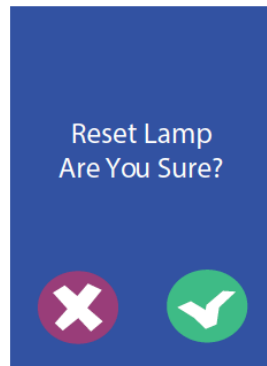

Fig 2A

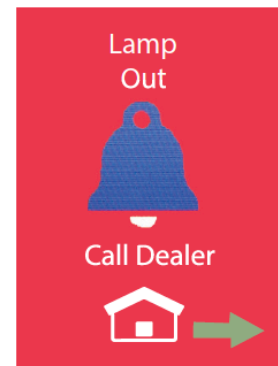

Fig 3



Fig 3A

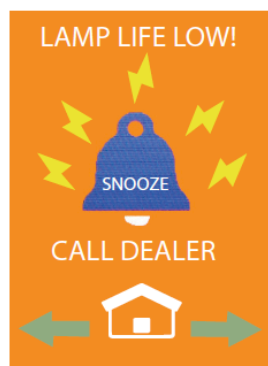

Fig 4

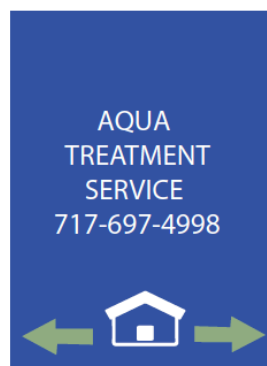

Fig 5



Fig 5A

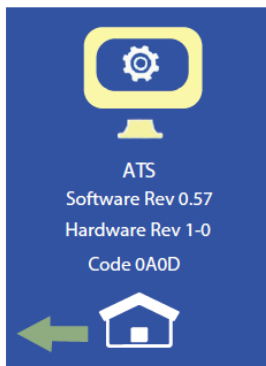

Fig 6

# Sanitation Procedure

## HOW TO DISINFECT A WATER SYSTEM:

Every new well, or existing water supply system that has been disrupted for service or repair, should be disinfected before it is returned to use. Water in the well and storage tank should be treated with a strong chlorine solution to destroy disease organisms. All pipelines and fixtures in the distribution system should be rinsed and flushed with chlorinated water. Upon installation of a U.V. disinfection unit or yearly bulb replacement service, disinfection with chlorine to initially flush the system is recommended to assure line sanitation prior to U.V. start up.

The source of chlorine can be ordinary household liquid laundry bleach (about 5.25% available chlorine). The quantity required depends on the volume of water to be treated. The United States Environment Protection Agency (EPA) indicated that about 100 parts of chlorine, by weight, mixed in a million parts of water will destroy essentially all water-borne disease organisms. Table 1 shows the quantity of liquid bleach required to disinfect wells of various diameters and depths.

## DISINFECTION PROCEDURE:

1. Remove the cap or seal from the casing and measure the depth of the water in the well, then refer to Table 2 to determine how many chlorine pellets should be used. In some instances removing the seal to measure the water can be a difficult task, and it is easier to estimate well and water depth from well log or other records.
2. Remove well cap and determine if there is an unobstructed path from the top of the well to the water level. If it is not possible to remove the well cap, remove vent or sanitation access plug.
3. Drop one pellet into the well and listen to hear if it hits the water. If the pellet hits the water, drop one-half the number of pellets determined to be needed into the well. These will sink to the bottom and sanitize the lower part of the well.
4. Mix the remaining pellets in a few gallons of water in a CLEAN plastic container and pour the solution into the well.
5. In order to mix the chlorine thoroughly throughout the entire water system, it is necessary to recirculate the water in the well. This can be accomplished by connection a hose to an out side faucet that is located after the pressure tank. Use hose to run water back down the well (this also rinses upper portion of well). After about 15 minutes of recirculation the water, a strong chlorine odor should be apparent. Turn off hose.
6. Bypass water softener and filters and open each water outlet in the water system until chlorine is present in water. This procedure assures that all the water in the system is chlorinated.
7. Allow the chlorinated water to stand in the system for at least one (1) hour, and preferable overnight. After this, open an outside faucet system until water runs chlorine free. Repeat flush operation on each faucet in system.

## NOTE:

**A.** Chlorine may break loose iron deposits, slime and organic material. This material will make the water discolored. The material broken loose may plug pump screens. Do not

continue to run pump if water doesn't flow.

**B.** The high level of chlorine required to sanitize a water system is corrosive to most metals and chlorine solution must not be allowed to remain in water system more than 36 hours before being completely flushed from system.

8. After system has been completely flushed, perform a bacteriological analysis on the water following all applicable procedures.

**NOTE:** Always follow the sanitizing procedure required by applicable state or local laws.

EPA Registered: Well sanitizer pellets are EPA Registered for sanitizing potable water. EPA Registration No. 50510-1

**LARGE DIAMETER WELLS:** Dug or bored wells should be disinfected in the same way as a drilled one. Lower the water level as much as possible, remove the sand, silt and debris, and then treat with the chlorine solution. Mix thoroughly by circulating the water back into the well and use the hose to rinse the interior lining of the well. Do not try to disinfect an unprotected, unlined well because new seepage or surface contamination will flow into the water nearly as fast as you can disinfect it. Disinfect the pipeline distribution system as indicated for drilled wells.

**SPRINGS AND CISTERNS:** Mix about ½ cup of household bleach in 5 gallons of water and use this to scrub the walls of the spring box or holding tank. With a constant flow of fresh water from the spring, there is probably no way of detaining the chlorine solution in the reservoir for more than a few minutes. However, the chlorinated water should flow through the pipeline to disinfect the distribution system. Cisterns can be disinfected in the same way but a source of clean water will be needed to flush the dirty waste out of the system.

For additional information about how to protect wells and springs and keep them from becoming contaminated, call or visit your local Cooperative Extension office, or your nearest certified water treatment specialist.

**TABLE 1 \*\*** Quantity of solution mixed - 5.25% available chlorine (laundry bleach) for disinfecting wells, or 52,500 P.P.M..

WQA recommends 50mg/l or ppm chlorine concentration.

Formula:  $C2 \times V2 / C1 = V1$

C1= Household Bleach (52,500 P.P.M.)

V1= Chlorine Amount Needed

C2= 50 mg/L      V2= 80 gallons holding time

I.E.  $50\text{-ml/g} \times 80 \text{ gal} = 4000/52,500 = .08 \text{ gallons of chlorine (5.25\%)}$

$.08 \text{ gal chlorine (5.35\%)} \times 128 \text{ (oz/gal)} = 10.24 \text{ oz (5.25\%)}$

Dug Wells - 3 to 4 feet diameter - 4 cups per foot of water

Drilled Wells - 3 to 8 inch diameter - 1 cup per foot of water

# Sanitation Procedure Continued

## TOO MUCH CHLORINE IS BETTER THAN TOO LITTLE:

\*\*In situations where it is inconvenient to determine depth of water or diameter of a drilled well, a minimum of 1/2 gallon of household bleach may be used for wells up to 8 inches in diameter with estimated to be less than 80 feet deep; 1 gallon should be used for similar size wells with water deeper than 80 feet. In case of a well yielding more than 50 gallons per minute, special procedures are required. Seek the advice of a certified water treatment specialist.

Wait a day or two before you have another sample tested. Do not take a sample for testing if the odor of chlorine is still present in water.

**REMEMBER** - To make your water supply safe:

- Locate your well properly.
- Protect it from surface contamination.
- Test water periodically for coliform bacteria. (Home-yearly, Farm-2X yearly)
- Chlorinate, or filter and disinfect the water if necessary.

### Plumbing Line Sanitation Only:

When installing an ultraviolet disinfection system, a prefilter with sump may serve as a source to sanitize the water lines only. For whole system disinfection follow procedure as outlined above.

**Source:** The Pennsylvania State University College of Agriculture Cooperative Extension.

## How to Sanitize a Water System Using Well Sanitizer Pellets

**TABLE #2**

**NOTE:**

Pellets Weight = 1.14 gram each, 25 pellets/oz., 400 pellets/lb.

1 cup of pellets = 1/2 lb., or 200 pellets, or 8 oz.

To produce a 400 P.P.M. chlorine concentration, to sanitize a water system, use one-half (1/2) pound chlorination pellets for each 100 gallons of water in the system (1/2 lb/100 gal= 8 oz/100 gal= 200 pellets/ 100 gal= 1 cup pellets/100 gal). Table 2 shows how many pellets too use per 100 feet of water in various diameter wells.

**TABLE #2**

Well Diameter Inches	Weight of Pellets lbs. - oz.	Cups of Pellets	Number of Pellets
2	0 - 1.5	1/4	40
3	0 - 3.0	2/5	80
4	0 - 6.0	3/4	140
5	0 - 8.0	1	200
6	0 - 12.0	1-1/2	300
8	1 - 5.0	2-1/2	500
10	2 - 0	4	800
12	3 - 0	6	----
24	12 - 0	24	----
36	26 - 0	---	----

# Maintenance

## QUARTZ SLEEVE:

Installation of the Quartz Sleeve:

Always handle quartz sleeves carefully to prevent breaking or chipping. The quartz sleeves are to be clean and free of fingerprints before installing.

After unplugging the unit, remove the brass dust cap and electrical connection. Then remove brass end nut. Install the quartz sleeve through the stainless steel threaded nipple until it is centered in the quartz spring. Use a small amount of plumber's grease and install the O-ring around the quartz sleeve. Avoid riding the O-Ring on any threaded part of the nipple. Hand-tighten the brass end-nut to form a compression seal around the quartz sleeve. Avoid overtightening the nut, which may cause a fracture on the end of the quartz sleeve. Under normal operation conditions, hand-tightening will provide a 100 psi seal. Do not use any devices to tighten end nut.

After you have tightened the brass end nut and all other plumbing connections, open the outlet valve. Slowly open the inlet valve and flush out all remaining air. Then close the outlet valve and slowly open the inlet valve fully. Check the unit for leaks. If you find a leak at the brass end-nut, tighten the brass end-nut further. If the leak continues, drain the unit and inspect the quartz O-Ring and quartz sleeve for proper seal. Once you complete checking the unit, reassemble O-Ring and tighten brass end-nut. Repressurize the unit and check again.

## REQUIREMENTS FOR CLEANING THE QUARTZ SLEEVE:

As water passes through the U.V., minerals, debris and other matter in the water may deposit onto the quartz sleeve. After sufficient film has formed on the quartz sleeve, the ability of the ultraviolet germicidal rays to pass through the quartz sleeve and into the water may be impaired. Therefore, it is necessary to determine a cleaning schedule for the quartz sleeve. The frequency will depend on the specific type of water conditions. If the water has been processed through deionization, reverse osmosis, or is distilled, cleaning may be required only once per year. If untreated water is used, the cleaning frequency will vary. A minimum of once yearly is standard recommendation for cleaning and lamp replacement. Contact your local dealer for scheduling this service. Your specific situation will vary the frequency time according to the water quality of the home or facility application.

## QUARTZ SLEEVE CLEANING PROCEDURES:

To clean the quartz sleeve, turn off the water flow to the disinfection unit, turn power off, and at a separate faucet or valve relieve the water pressure from the UV. Then disconnect the electrical service to the lamp pins. Carefully remove the U.V. lamp. Loosen the end nut with O-Ring and remove the quartz sleeve. The quartz sleeve may then be washed with a mild soap and hot water solution and rinsed clean with hot water. Should this be insufficient to clean the quartz sleeve, a mild acid may be used (i.e. vinegar). Be certain to follow all recommended safety and handling procedures on the acid

container. It is important to handle the quartz sleeve with care to prevent breakage. Make certain that all finger prints are wiped clean before reinstalling (see installation of the quartz sleeve). Replace O-Ring [ATS8-544(1)] every time a quartz sleeve is cleaned or replaced. We recommend replacing the quartz sleeve once a year.

## U.V. LAMPS:

### INSTALLATION OF THE ULTRAVIOLET LAMPS:

**\*\*DO NOT PUT POWER ON AT THIS TIME!\*\***

**CAUTION: Never operate or look directly at U.V. lamp outside the disinfection chamber.**

Make sure unit is unplugged when installing or servicing ultraviolet lamp. Remove any paper tabs on the U.V. lamp and avoid allowing fingerprints and other debris to deposit. Carefully place the lamp inside the quartz sleeve leaving enough space to connect the socket connector to the lamp pins. Then gently slide the brass dust cap over the end nut, securing the lamp and protecting it from dust.

### ULTRAVIOLET LAMP MAINTENANCE REQUIREMENTS:

The U.V. lamp is rated for 9,000 hours of continuous use. After this period of time, the U.V. lamp has undergone a photochemical change. While the lamp will not normally be burned out, the lamp quartz may no longer emit the 254-nm shortwave U.V. to effectively kill bacteria. Failure to replace the U.V. lamps every 9,000 hours may cause bacteriological breakthrough. Should the use of the disinfection unit be intermittent, in no case should the U.V. lamp be used for more than 24 months regardless of the number of hours of operation due to normal shelf life degradation of the U.V. bulb. Changing the quartz sleeve should be done at the same time U.V. lamp replacement is scheduled.

It is recommended that your water supply be tested periodically (yearly) through your local health department or approved certified laboratory.

## ELECPFCAL:

The PFC series are furnished with 6' line cord that will plug into a 120V outlet. Electrical receptacles must be properly grounded for safe operation. Improper grounding will void any warranty.

When possible use a separate breaker to minimize voltage fluctuations and avoid accidental shut off. After unit is installed and water is turned on, plug the unit into 120V wall receptacle. View lamp operation through safety Sight Port lens.

NOTE: Avoid exposing your eyes to U.V. light.

# Parts Breakdown PFC-8IC

ITEM NO.	PART NUMBER	DESCRIPTION	QTY.
1	ATS-476D	Domed Quartz	1
2	ATS-268	Top Mounting Bracket	1
3	ATS-5172	Sightport Lens	1
4	ATS-5173	Orange .7" OD Viewport O Ring	1
5	ATS-5171	Sightport Nut	1
6	ATS5-410	Lock Nut	1
7	ATS8-546	End Nut Oring	1
8	ATS-8GPM	Flow Control	1
9	STS-8GPM	8 Gallon Per Minute Bottom Feed Assembled Chamber	1
10	ATS-269	(OPTIONAL) Bottom Mounting Bracket	1
11	ATS-PFC	PFC CONTROL BOX	1
12	ATS5-414	End Nut	1
13	ATS4-450IC	IC UV Lamp	1

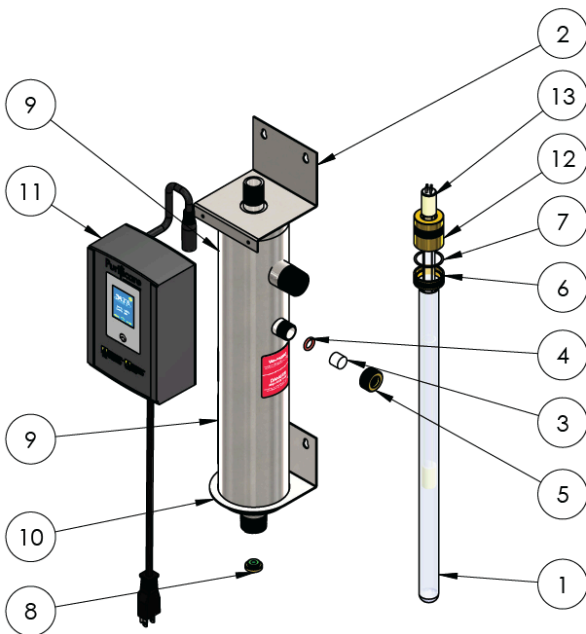

# Parts Breakdown - PFC-12IC

ITEM NO.	PART NUMBER	DESCRIPTION	QTY.
1	ATS1-759D	Domed Quartz	1
2	ATS4-739IC	IC UV Lamp	1
3	ATS-5173	Orange .7" OD Viewport O Ring	1
4	ATS-5172	Sightport Lens	1
5	ATS-5171	Sightport Nut	1
6	ATS5-410	Lock Nut	1
7	ATS8-544	Quartz Sleeve Black 1.2" OD ORing	1
8	ATS-12GPM	12 GPM Flow Control	1
9	STS-12GPM	Assembled PFC-12 Chamber	1
10	ATS-268	Top Mounting Bracket	1
11	ATS-269	Bottom Mounting Bracket	1
12	ATS-PFC	PFC Control Box	1
13	ATS5-414	Brass End Nut	1

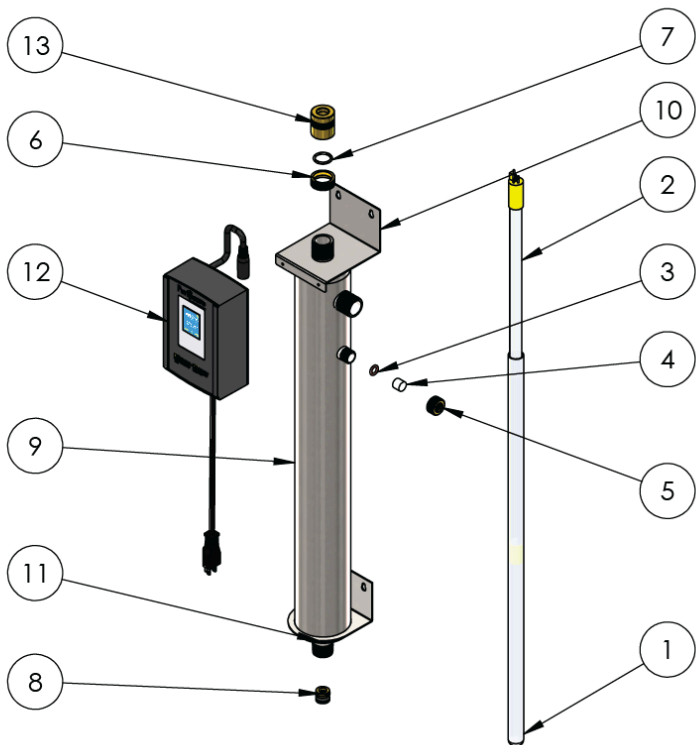

# Parts Breakdown - PFC-20IC

ITEM NO.	PART NUMBER	DESCRIPTION	QTY.
1	ATS-832D	Domed Quartz	1
2	ATS4-810IC	IC UV Lamp	1
3	ATS-5173	Orange .7" OD Viewport O Ring	1
4	ATS-5172	Sightport Lens	1
5	ATS-5171	Sightport Nut	1
6	ATS-20GPM	20 GPM Flow Control	1
7	ATS8-544	Quartz Sleeve Black 1.2" OD ORing	1
8	STS-20GPM	20 Gallon Per Minute Bottom Feed Assembled Chamber	1
9	ATS-PFC	PFC Control Box	1
10	ATS5-414	Brass End Nut	1
11	ATS5-410	Lock Nut	1
12	ATS-270	Top Mounting Bracket	1

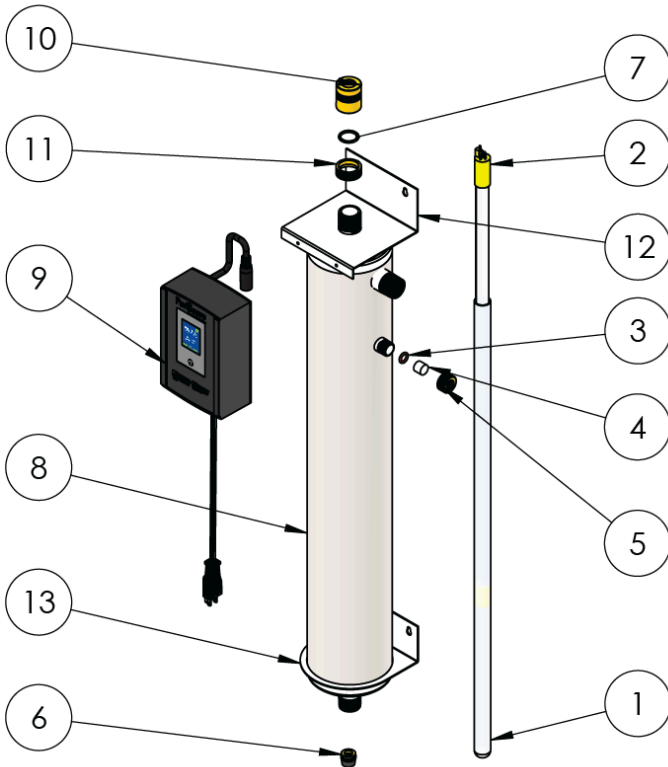

# Circuit Board Layout

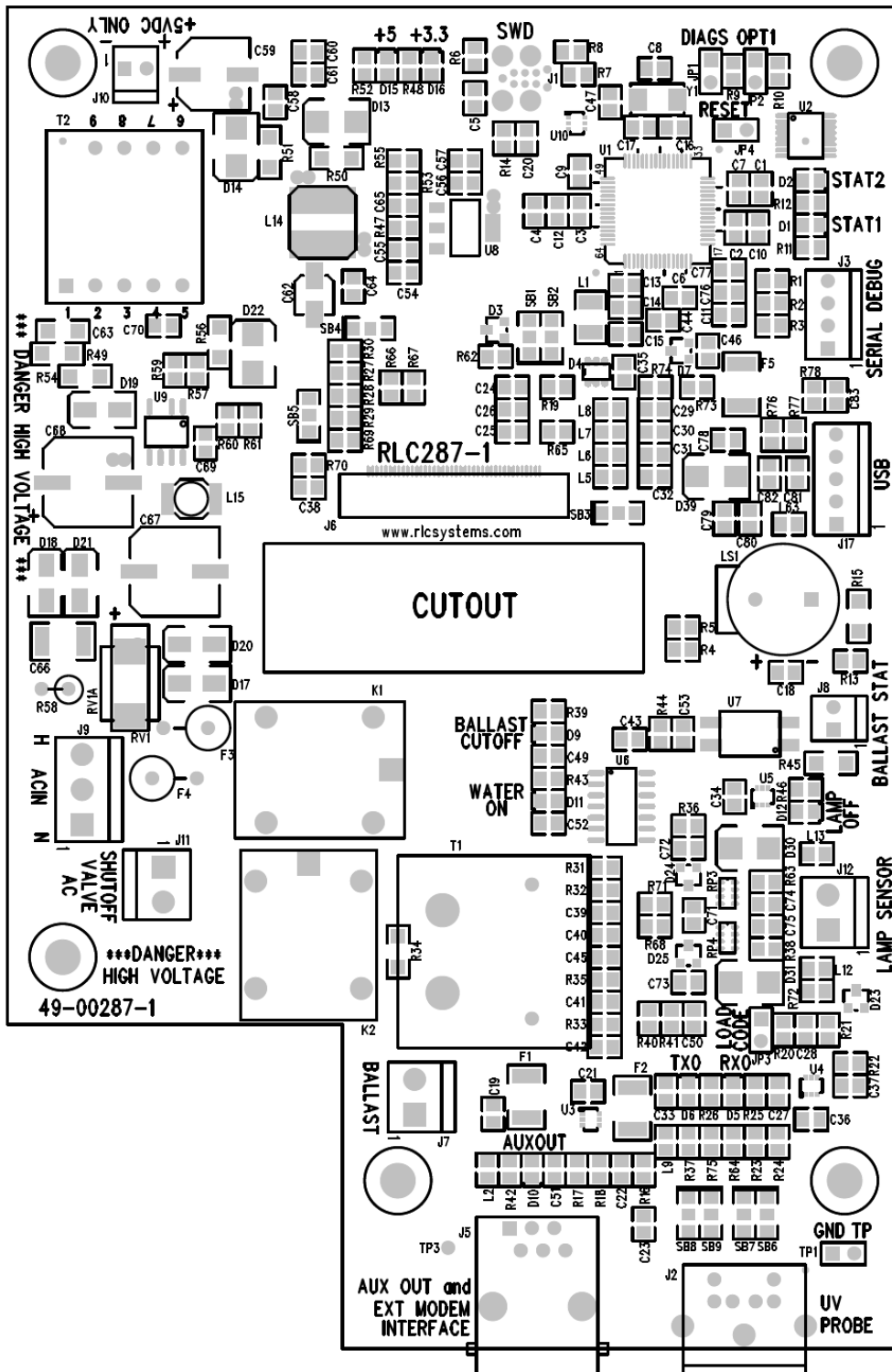



# Wiring Diagram

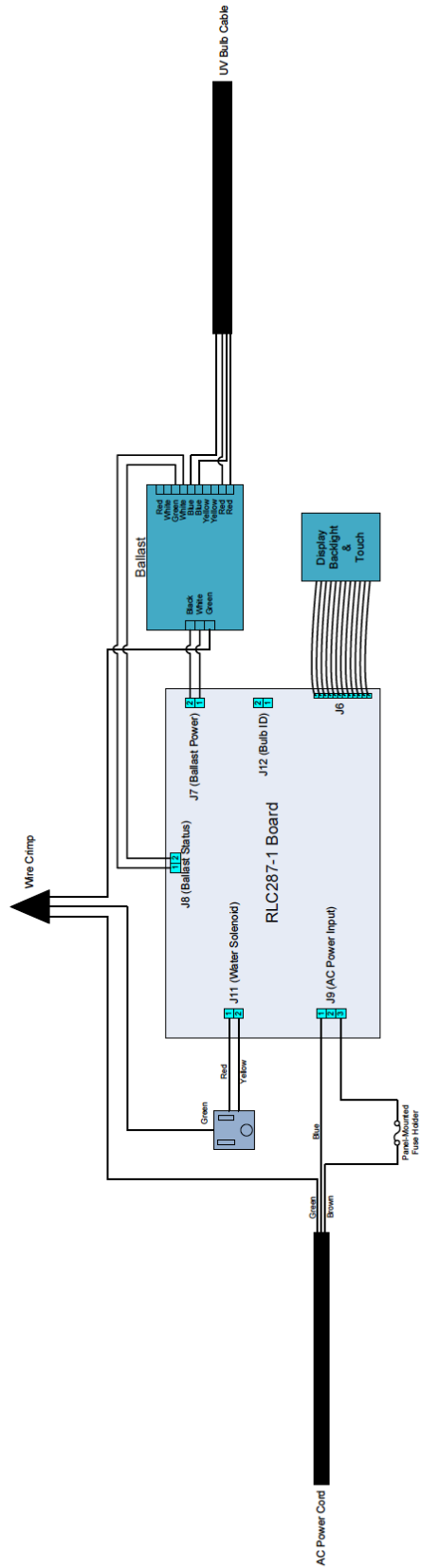

# Troubleshooting

## TROUBLESHOOTING GUIDE

PROBLEM	CAUSE	CORRECTION
U.V. lamp will not light	Check input voltage if below or above 120 volts	Install a voltage regulator
	Electrical cord disconnected or outlet defective	Check, replace
	Defective U.V. lamp	Replace Lamp
	Defective lamp ballast	Check output voltage Replace ballast
	Loose open-circuit wire	Trace out and repair
Leak at quartz nipple	Defective or cracked O-Ring	Replace O-Ring
	O-Ring not seated properly	Replace O-Ring
	Cracked Quartz Sleeve	Replace Quartz Sleeve

# Sterile Water Sample Procedures

## SUGGESTED PROCEDURE FOR OBTAINING STERILE WATER SAMPLES:

Prior to taking the water sample, be sure to have on hand an adequate supply of sterile bottles (as shown in Fig 1). These sterile bottles should be obtained from a reputable laboratory and should have been autoclaved and contained within a plastic outer wrapping.

1. Prior to taking the sample, it is imperative that the sample valve, faucets, etc. be opened at full force for a complete three and a half minutes.
2. After the valve has been fully opened for three and one half minutes, reduce the flow to a reasonable stream of water. Flow to drain an additional three minutes.
3. Open the sterile bottle or sterile container being used. Holding the cap in a down position, the operator should then hold his breath while taking the sample so as to avoid oral contamination of the sample. The operator must not allow his finger to touch the inside of the cap or the neck of the bottle.
4. After the sample has been taken, the cap should immediately be tightly placed on the sample container.
5. The sample container should be placed in a plastic wrapping, kept cool, and should be taken to the laboratory for testing as soon as possible.

We recommend duplicate samples be taken at each test station during each specific test so as to avoid loss of sample through laboratory error and to insure reasonable validity through comparison.

Check with your local laboratory to assure proper sampling and submittal procedure.



Fig 1

# Specifications

## Purificare Systems with Chipped Lamp

Model #	Max. Flow GPM	No. Lamps	KW @ 120 V	AMP @ 120V	AMP @ 220V	Pipe Size	Overall Dimensions L x W x D	Unit Weight
PFC-8IC	8	1	0.048	0.4	0.088	1" MNPT	24" x 6" x 8"	8.5 lbs.
PFC-12IC	12	1	0.048	0.4	0.088	1" MNPT	36" x 6" x 8"	11.5 lbs.
PFC-20IC	20	1	0.048	0.4	0.088	1" MNPT	40" x 6" x 8"	15.5 lbs.

### Parts Breakdown:

1. Mounting Bracket
2. Outlet
3. Site Port
4. Quartz Sleeve
5. UV Lamp
6. Inlet
7. Quartz Sleeve Stabilizer
8. Bottom Mounting Bracket

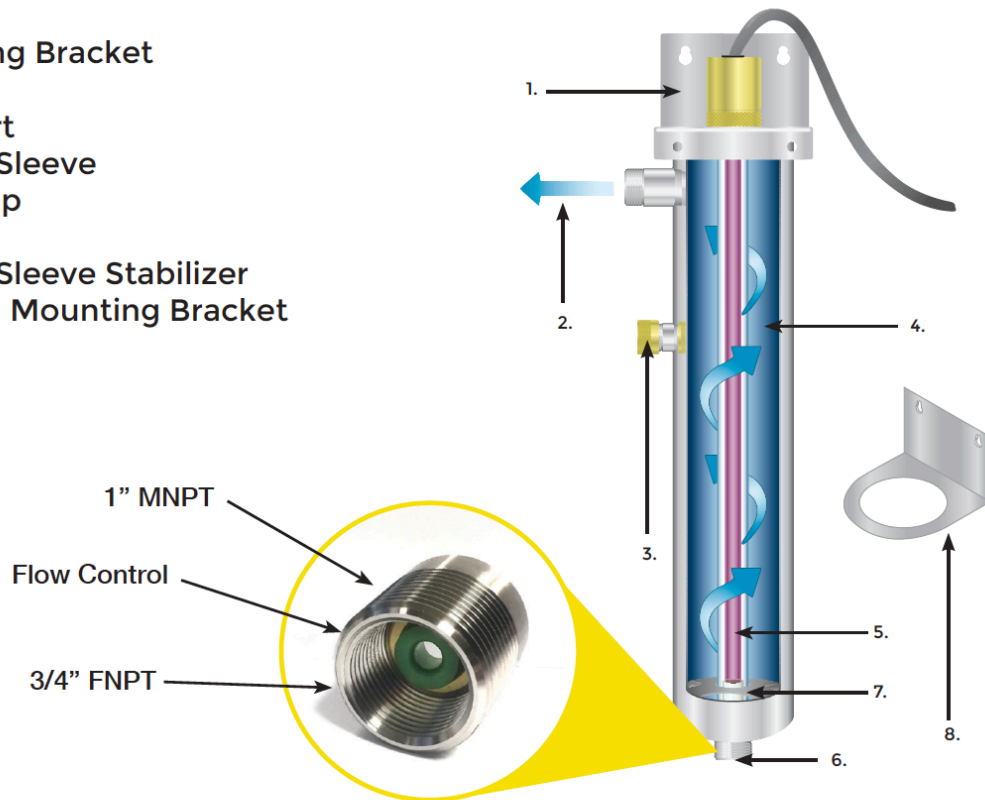

### OPTIONAL ACCESSORIES



#### Solenoid:

This solenoid acts as a fail safe shut-off valve. Providing extra protection for the system.



#### UV Probe:

UV dosage metering device. This UV Probe reads only the 254-nm intensity output of the Ultraviolet Light within the UV treatment chamber. Optional on PFC units only.







# Warranty



REV. January, 2019

## MANUFACTURER'S LIMITED WARRANTY

In accordance with the Manufacturer's warranty, and subject to the conditions hereinafter set forth, ATS will repair or replace to the original user or consumer, equipment, parts or components found to be defective in manufacturing or workmanship.

### **WARRANTY PERIODS:**

UV Chambers	10 yrs.
Electrical Components (excludes UV lamp)	2 yr.
UV Lamp, Quartz Sleeve	90 days prorated

**WARRANTIES NOT APPLICABLE:** To defects or malfunctions resulting from failure to properly install, operate or maintain the unit in accordance with printed instructions; failure to use ATS authorized replacement parts, to failures resulting from shipment or handling, abuse, accident, negligence, freezing, fire or heat, direct exposure to weather or sunlight, water temperatures and pressures exceeding specifications, flooding or other acts of God not considered normal operating condition; to normal maintenance services and the parts used in connection with such service; to units which are not installed in accordance with applicable local codes, ordinances and good trade practices; if the unit is moved from its original installation location; or if unit is used for purposes other than for what it was designed and manufactured.

**LABOR COSTS, LIABILITY:** Aqua Treatment Service, Inc., shall **IN NO EVENT** be responsible or liable for the cost of field labor or other charges incurred by any customer in installing, removing and/or reaffixing any ATS, part or component thereof, or be liable for any injury, loss or damage, direct or indirect, special or consequential, arising out of the use of, misuse, or the inability to use such product. Before use, Distributor, Dealer or User shall determine the suitability of the product for his/her intended purposes, and shall assume all risk and liability in connection therewith.

**RETURNS:** A **RETURN MERCHANDISE AUTHORIZATION NUMBER (RMA #)** is required on **ALL RETURNS**. Contact ATS to obtain this number. The RMA # **MUST** be clearly written on the outside of the package. Address shipments to the Return Department ATS, 194 Hempt Road, Mechanicsburg, PA, 17050, and freight prepaid. All returns should be accompanied with a written description of mode or reason of failure.

The customer must order ATS replacement parts if required as a standard purchase until the defective part is received and evaluated by the factory. ATS will inspect, test, and determine the cause of defective components or parts. ATS at its sole discretion will make necessary repairs to or replace components. ATS will determine the extent of the warranty coverage and the proper warranty credit to be applied. The return freight will be credited to the customer for warranty repairs or replacements.

For your warranty protection, the warranty card must be completed and returned to ATS within 10 days of installation. In the absence of other suitable proof of installation date, the effective date of this warranty will be based on the date of manufacture plus 30 days.

**This warranty gives you specific legal rights and you may also have other rights, which vary, from state to state.**